



Project:

Item Number:

Quantity:

SIGNATURE SERVER®: HOT/COLD FOOD STATION



Base pictured with stainless corner strips for laminate finish.

DESCRIPTION

Vollrath's Hot/Cold Food Station is constructed of 18-gauge carbon steel clad with black vinyl, or optional laminate finish (all-stainless construction also available). All exposed stainless steel is type 304 polished with #4 finish or equal. Unit is mounted on heavy-duty, semi-hidden 4" (10.16 cm) diameter ball bearing swivel-type casters with non-marking treads. All casters come complete with locking plate brakes. Touch Temp® programable electronic control panel will adjust the 625 watt heating element in each individual food well. Top shelf constructed of one piece 18-gauge stainless steel with each hot well opening 19⁷/₈" x 11⁷/₈" (50.48 cm x 30.16 cm). Cold well constructed of 18-gauge stainless steel and the opening is 19⁷/₈" x 24" x 8" (50.48 cm x 60.96 cm x 20.32 cm) deep. Integral drain is provided with rubber bar plug. Inner body is insulated with thick foamed-in-place polyurethane insulation. Manifold drain for hot wells is standard. NSF4 certified. Non-refrigerated model certified under NSF2.

LIGHTING (Requires breath guard) (Bulbs not included)

Note: Lighting options for breath protector components require that 120V AC, 120/208V AC or 120/240V AC be selected.

Incandescent/Infrared (Bulbs not included)

Attractively display and merchandise food; or provide heat from above.

- 36433 Incandescent/Infared, 74" (187.96 cm) Length

Note: 25W incandescent bulbs recommended over cold well.

Fluorescent (Bulbs not included)

Illuminates food attractively while providing more room under breath guard. Includes shield for light tube.

- 36423 Fluorescent, 74" (187.96 cm) Length

Agency Certifications



MODELS:

Non-Refrigerated

- 36291
- 36191
- 37091

Refrigerated

- 36295
- 36195
- 37095

Description

- 27" (68.58 cm) Height
- 30" (76.20 cm) Height
- 34" (86.36 cm) Height

Voltage Specifications

- 120/240V, 1PH
- 240V, 1PH

- 208V, 1PH
- 120/208V, 1PH

- 120V, 1PH
- Transformer

Note: Refrigerated cold pans require 120V AC.

Note: Transformers may be required for overseas shipment of refrigerated cold pans.

Optional Finishes

- 96682 Matte Finish Brand _____ Color _____
- 96689 Woodgrain Brand _____ Color _____
- 96695 All-Stainless

Optional solid surface or laminate tops available. Contact the factory.

BREATH GUARD

Cafeteria Breath Guard

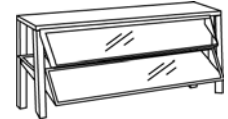
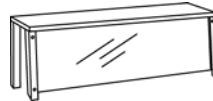

Single Shelf

Twelve inch (30.48 cm) wide shelf is constructed of 18-gauge stainless steel and front panel is heavy-duty 1/4" (.63 cm) clear acrylic. Serving shelf and acrylic panel attach to 1" (2.54 cm) square tubular stainless steel uprights.

Double Shelf

Top shelf is 18-gauge stainless steel and 12" (30.48 cm) wide. Intermediate shelf is 1/4" (.63 cm) acrylic. Shelves mounted to 1" (2.54 cm) square tubular stainless steel uprights. Breath guards are 1/4" (.63 cm) clear acrylic and are adjustable/pivot to provide access to serving areas.

- 37313 Single Shelf, 74" (187.96 cm) Length
- 37323 Double Shelf, 74" (187.96 cm) Length

Access Breath Guard

Top shelf constructed of 18-gauge carbon steel clad with black vinyl, optional laminate or stainless steel. Side and end panels constructed of 1/4" (.63 cm) clear acrylic. Uprights built of 18-gauge stainless steel. Provides 12" (30.48 cm) height clearance/serving opening when in use. Adjustable Access Breath Guard provides serving opening range of 9"-15" (22.8-38.1 cm) in one inch (2.54 cm) increments. NSF certified.

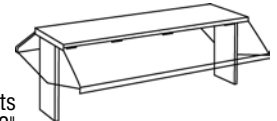

- 36373 Adjustable, 74" (187.96 cm) Length
- 36371 Non-Adjustable, 74" (187.96 cm) Length

Buffet Breath Guard

Constructed of 18-gauge 1" (2.54 cm) square tubular stainless steel uprights. Panels made of 1/4" (.63 cm) clear acrylic. Side panels provide 12" (30.48 cm) clearance/serving opening when attached to Vollrath Signature Server® Base.



- 36303 Buffet Breath Guard, 74" (187.96 cm) Length

Optional powdercoat or brass breathguards available. Contact the factory.

Approvals

Date:

--	--



www.vollrathco.com

The Vollrath Company, L.L.C.
1236 North 18th Street
Sheboygan, WI 53082-0611
U.S.A.
Main Tel: 800.624.2051
Service Tel: 800.628.0832
FAX: 800.752.5620

Vollrath of Canada, Ltd.
6320 Danville Road, Unit 1
Mississauga, Ontario L5T 2L7
Canada
Tel: 905.565.1167
Tel: 800.695.8560
FAX: 905.565.1168

SIGNATURE SERVER®: HOT/COLD FOOD STATION

ACCESSORIES AND ADD ONS

Tray Slide with Mounting Kit

Constructed of 18-gauge stainless steel with 4 ribs. Bracket provides 4¾" (12.07 cm) tray slide height adjustment. 11½" (29.21 cm) wide with 1" (2.54 cm) turned down flange. Locking brackets on each end to join stations together. Adds 5½" (13.97 cm) to width of unit in folded position.

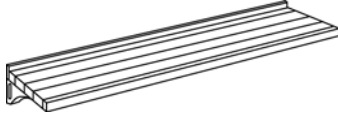

- 37524 Tray Slide with Mounting Kit 74", (187.96 cm) Length

Stationary Legs

Constructed of plated metal. Threaded insert with height adjustment of 1" (2.54 cm).

- 36921 Stationary Legs



Adjustable
from 4" to 5"
(10.16 cm to
12.7 cm)

End Shelf

Constructed of 18-gauge stainless steel with fold-down style mounting bracket. Attaches to 46" (117 cm), 60" (152.4 cm) and 74" (187.96) Signature Servers. Adds 4½" (11.43 cm) to length of unit in folded position. Must be factory installed.

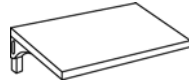

- 37570 End Shelf, 18" x 28" (45.72 cm x 71.12 cm)

Plate Rest or Stainless Cutting Board with Mounting Kit

Made of 18-gauge stainless steel with fold-down style mounting bracket. 7" (17.78 cm) wide with 1" (2.54 cm) turned down flange. Locking brackets on each end to join stations together. Adds 4½" (11.43 cm) to width of unit in folded position.

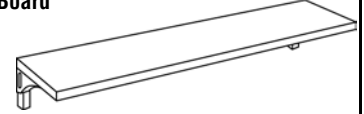

- 37514 Plate Rest with Mounting Kit, 74" (187.96 cm) Length

Cutting Board

Wood cutting board made of 1½" (2.86 cm) thick sectional kiln dried maple. Poly cutting board is 1" (2.54 cm) thick. Both NSF certified. Boards have chrome plate fold-down style mounting brackets. Removable without tools. Adds 4½" (11.43 cm) to width of unit in folded position.



- 37552 Wood Cutting Board, 74" (187.96 cm) Length
 37562 Poly Cutting Board, 74" (187.96 cm) Length

False Bottom

Helps ice keep longer, reducing labor. This sturdy, perforated rack allows melted ice to drain away from pans or containers.

- 36913 Perforated False Bottom — 1" (2.54 cm) nominal height

DIMENSIONS

- Dimensions in inches (cm).

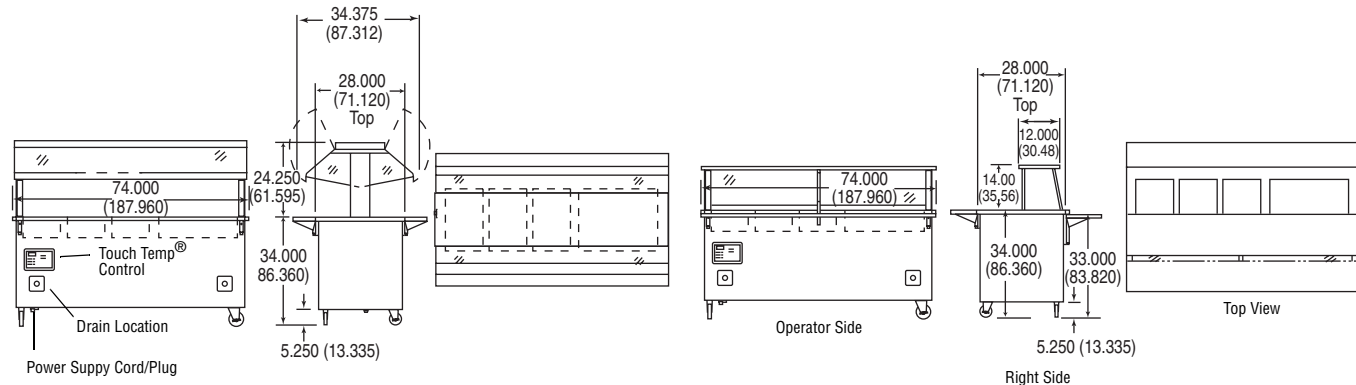

- Custom Design

Note: In the interest of continued improvement, we reserve the right to change specifications without notice.



www.vollrathco.com

The Vollrath Company, L.L.C.
1236 North 18th Street
Sheboygan, WI 53082-0611
U.S.A.
Main Tel: 800.624.2051
Service Tel: 800.628.0832
FAX: 800.752.5620

Vollrath of Canada, Ltd.
6320 Danville Road, Unit 1
Mississauga, Ontario L5T 2L7
Canada
Tel: 905.565.1167
Tel: 800.695.8560
FAX: 905.565.1168

©2004 The Vollrath Company L.L.C. Form Number L35363 Rev. 3/04

Printed in USA