



Profit from the Eagle Advantage®

# Specification Sheet

## Short Form Specifications

Eagle 1800 Series Under Bar Sink, model \_\_\_\_\_. Top, sink bowls, front and backsplash to be heavy gauge type 304 stainless steel. Sinks to be 10" x 14" x 10" deep with 1½" drains and standpipes. 4½" high backsplash with provisions for faucet with 10" spout. 1½" O.D. galvanized tubular legs with adjustable bullet feet.



model #B5C-18 underbar sink

## Options / Accessories

- Stainless steel leg kits (see below)
- Leg & faucet kit (see below)
- Speed rail

Item No.: \_\_\_\_\_  
 Project No.: \_\_\_\_\_  
 S.I.S. No.: \_\_\_\_\_

## 1800 Series Underbar Sinks

### MODELS:

- B3L-2-18     B5R-18
- B3R-2-18     B5C-18
- B4C-2-18     B6C-18
- B4L-2-18     B6C-4-18
- B4R-2-18     B7C-18
- B4L-18         B7C-4-18
- B4R-18         B8C-18
- B5L-18         B8C-4-18

## Design and Construction Features

- New bullnose front edge.
- All units are modular, allowing for custom configuration using standard components.
- Top, front, and ends are heavy gauge type 304 series stainless steel construction.
- Back panels are galvanized steel.
- 10" x 14" x 10" (254 x 356 x 254mm) bowls.
- 1½" (38mm) drain with removable standpipe on sinks.
- Splash mount 4" (102mm) center faucet with 10" (254mm) spout.
- Available in a variety of sizes, from 3' to 8' (914 to 2438mm) length.
- Models offered with two-, three-, or four-compartment sinks, all of which are one-piece and deep-drawn.

Optional Kits for Underbar Sinks	
add suffix #	description
-SL	stainless steel leg assemblies
-SLF	stainless steel leg assemblies & stainless steel feet
-SLG	stainless steel leg assemblies & stainless steel gussets
-SLGF	stainless steel leg assemblies, stainless steel feet & gussets
-LF *	stainless steel legs and T&S faucet

\* Includes #305540 stainless steel legs and #313302 T&S faucet

**EAGLE GROUP**  
 100 Industrial Boulevard, Clayton, DE 19938-8903 USA  
 Phone: 302-653-3000 • Fax: 302-653-2065  
 www.eaglegrp.com

**Foodservice Division: Phone 800-441-8440**  
**MHC/Retail Display Divisions: Phone 800-637-5100**

For custom configuration or fabrication needs, contact our **SpecFAB® Division**.  
 Phone: 302-653-3000 • Fax: 302-653-3091 • e-mail: specfab@eaglegrp.com



**Spec sheets available for viewing, printing or downloading from our online literature library at [www.eaglegrp.com](http://www.eaglegrp.com)**



Profit from the Eagle Advantage®

Item No.: \_\_\_\_\_  
 Project No.: \_\_\_\_\_  
 S.I.S. No.: \_\_\_\_\_

# 1800 Series Underbar Sinks

## 3' (914mm) length

model #	weight	
	lbs.	kg
B3L-2-18	68	30.8
B3R-2-18	68	30.8

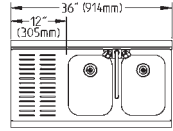

B3L-2-18

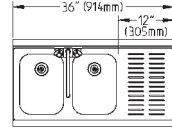

B3R-2-18

## 4' (1219mm) length

model #	weight	
	lbs.	kg
B4L-18	74	33.6
B4R-18	74	33.6
B4C-2-18	74	33.6
B4L-2-18	74	33.6
B4R-2-18	74	33.6

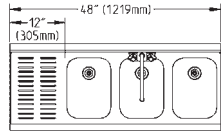

B4L-18

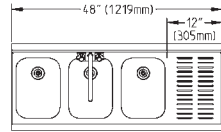

B4R-18

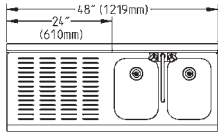

B4L-2-18

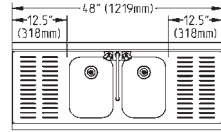

B4C-2-18

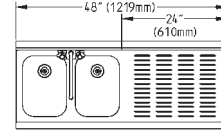

B4R-2-18

## 5' (1524mm) length

model #	weight	
	lbs.	kg
B5L-18	80	36.3
B5R-18	80	36.3
B5C-18	80	36.3

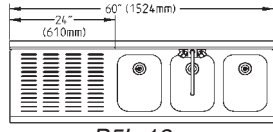

B5L-18

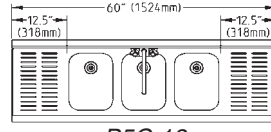

B5C-18

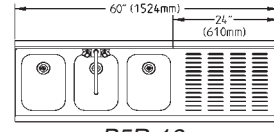

B5R-18

## 6' (1829mm) length

model #	weight	
	lbs.	kg
B6C-18	86	39.0
B6C-4-18	86	39.0

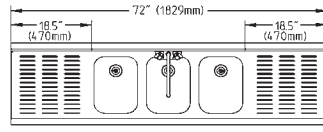

B6C-18

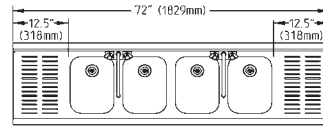

B6C-4-18

## 7' (2134mm) length

model #	weight	
	lbs.	kg
B7C-18	92	41.7
B7C-4-18	90	40.8

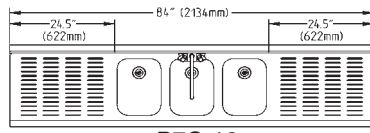

B7C-18

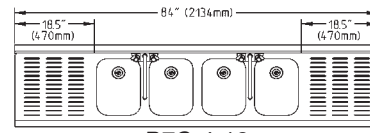

B7C-4-18

## 8' (2438mm) length

model #	weight	
	lbs.	kg
B8C-18	98	44.5
B8C-4-18	104	47.2

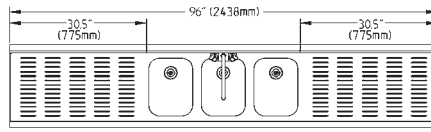

B8C-18

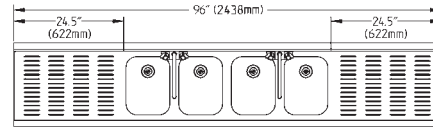

B8C-4-18

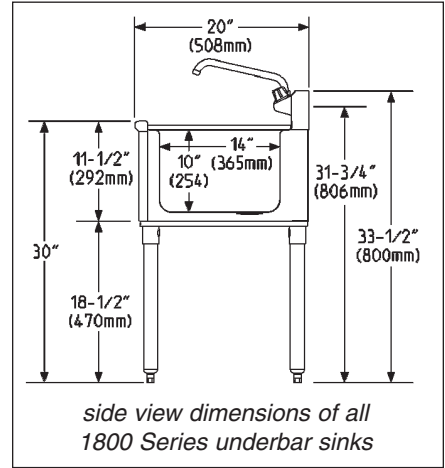

**EAGLE GROUP**  
 100 Industrial Boulevard, Clayton, DE 19938-8903 USA  
 Phone: 302-653-3000 • Fax: 302-653-2065  
 www.eaglegrp.com

Foodservice Division: Phone 800-441-8440  
 MHC/Retail Display Divisions: Phone 800-637-5100

Printed in U.S.A.  
 ©2010 by Eagle Group  
 Rev. 01/10

Spec sheets available for viewing, printing or downloading from our online literature library at [www.eaglegrp.com](http://www.eaglegrp.com)

Although every attempt has been made to ensure the accuracy of the information provided, we cannot be held responsible for typographical or printing errors. Information and specifications are subject to change without notice. Please confirm at time of order.