



Project _____
 Item # _____
 Quantity _____

Refrigerated Drop-In Wells

Models: CWB-1, -2, -3, -4, -5, -6

Hatco's Refrigerated Drop-In Well keeps pre-chilled food products at safe serving temperatures. Unique top angled inside wall design allows cold air to effectively blanket your food product to keep the food optimally cold and fresh.

This is a top mount unit that holds full-size pans, available in one-through six-pan configurations. The electronic control assembly can be conveniently mounted to either side of the condensing unit or remotely mounted up to four feet (1219 mm) from the unit (cannot be mounted over condensing coil).

Standard features

- Top mount unit holds full-size pans in 1- to-6- pan configurations
- NSF 7 approved cold wall construction utilizes R-404A refrigerant keeping food product cold without drying it out
- Adjustable condensing unit can rotate 90° or 180° on all models for easy venting adjustments and flexibility at installation
- Mobile condensing unit can be moved in 6.5" (165 mm) increments from end to center on the four-, five- and six-pan units (see drawing on page 2)
- Easy serviceability with a sight glass, service valves, dryer/filter and a receiver. Long, flexible refrigerant line (ability to pullout condensing unit) for service
- Auto-defrost is activated through an advanced electronic controller programmed at customer location
- Optimal insulation on sides and bottom ensure better cold retention
- Environmentally friendly insulation used throughout
- Matches the Hatco line of Heated Wells for a fully integrated look
- 1" NPT drain simplifies cleaning



Model CWB-6
 with accessory (hotel)
 food pans and additional
 support bar

Options (available at time of purchase only)

- Additional Four-Year Parts Only Warranty on the Compressor at Time of Unit Purchase
- Slant Kit to give Cold Wells a 5° tilt

Accessories

Pan Support Bars

- 12" (305 mm), hangs from 20" (508 mm) Pan Support Bar
- 20" (508 mm), hangs from pan shelf

Stainless Steel Food Pans:

- Third-Size (2.5" [64 mm] H)
- Half-Size (2.5" [64 mm] H)
- Full-Size (2.5" [64 mm] H)
- Full-Size (4" [101 mm] H)
- Full-Size (6" [152 mm] H)

- False Bottom (perforated false bottom)

Trivets:

- Half-Size (10.19" [259 mm] W x 7.625" [194 mm] D)
- Full-Size (10.125" [259 mm] W x 18" [457 mm] D)

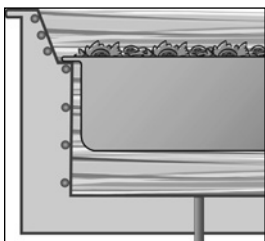

Unique angled inside wall design provides easy access and clear views, while allowing cold air to effectively blanket your food product



HATCO CORPORATION | P.O. Box 340500 Milwaukee, WI 53234-0500 U.S.A. | (800) 558-0607 | (414) 671-6350
 Fax: (800) 543-7521 | Int'l. Fax: (414) 671-3976 | www.hatcocorp.com | equipmentsales@hatcocorp.com | intlsales@hatcocorp.com



Refrigerated Drop-In Wells

Models: CWB-1, -2, -3, -4, -5, -6

Ordering Instructions:

Please specify the following with each order:

- Desired Voltage:**
120 for CWB-1, -2, -3, -4, -5, -6
220-240V for CWB-1, -2 or -3 only
- Number of Drop-In Wells Required:**
1-, 2-, 3-, 4-, 5-, or 6-pan as rectangular, full-size, 12" x 20" (305 mm x 508 mm)
- Electronic Control Assembly** can be mounted on either side of the Condensing Unit or remotely mounted up to 4 feet (1219 mm) from the unit (cannot be mounted over the condensing unit)

ALL MODELS Slant Option (gray highlight)

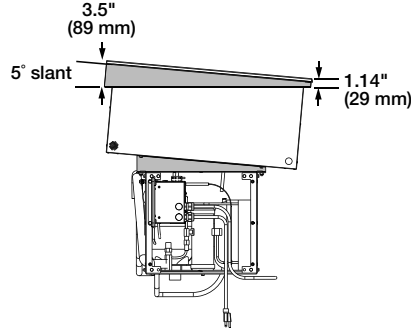

ALL MODELS False Bottom Accessory 1-part, 2- or 3-part, depending on pan size

Placed on bottom of unit

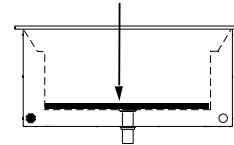

Model CWB-1

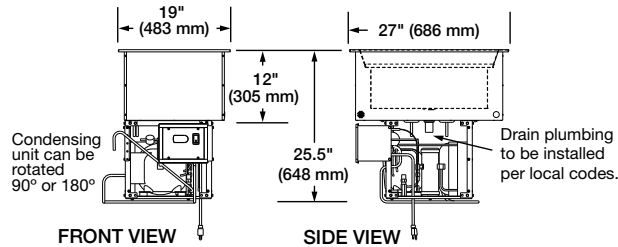

Model CWB-4

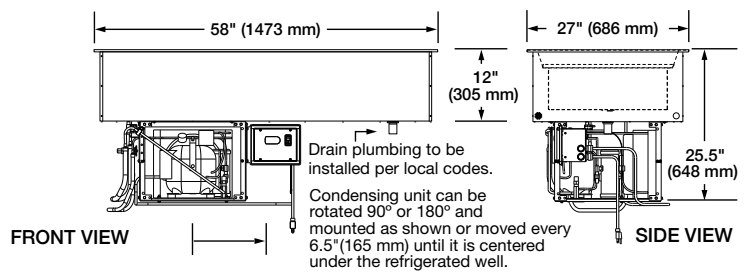

Model CWB-2

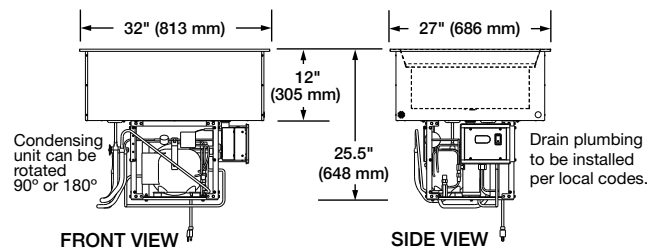

Model CWB-5

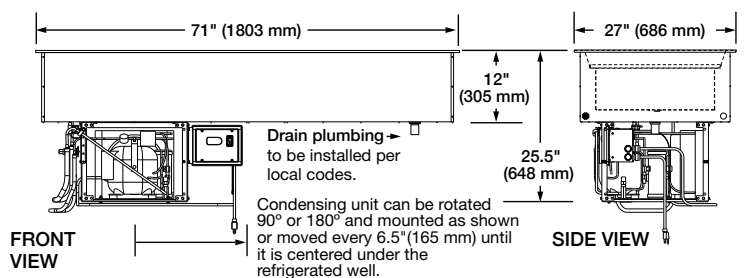

Model CWB-3

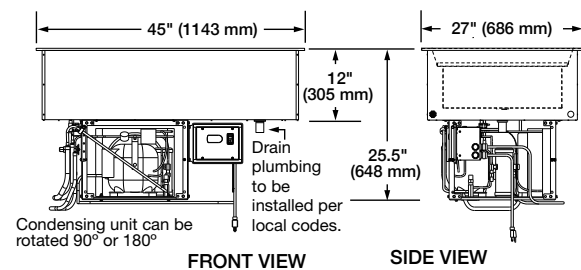

Model CWB-6

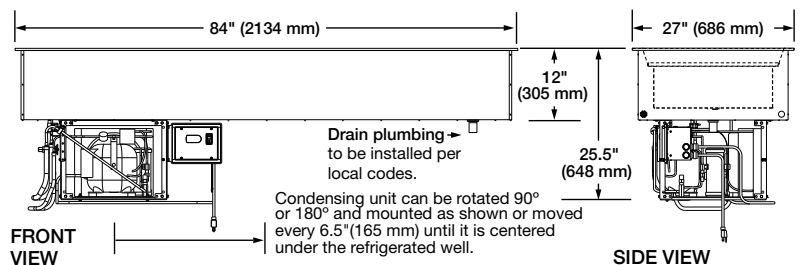



Refrigerated Drop-In Wells

Models: CWB-1, -2, -3, -4, -5, -6

Cutout Dimensions for Refrigerated Drop-In Wells

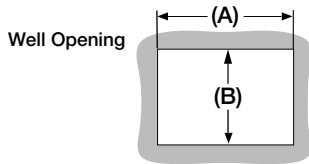

Model	Minimum Width (A)	Maximum Width (A)	Minimum Depth (B)	Maximum Depth (B)
CWB-1	17.125" (435 mm)	18" (457 mm)	25.19" (640 mm)	26" (660 mm)
CWB-2	30.125" (765 mm)	31" (787 mm)	25.19" (640 mm)	26" (660 mm)
CWB-3	43.125" (1095 mm)	44" (1118 mm)	25.19" (640 mm)	26" (660 mm)
CWB-4	56.125" (1426 mm)	57" (1448 mm)	25.19" (640 mm)	26" (660 mm)
CWB-5	69.125" (1756 mm)	70" (1778 mm)	25.19" (640 mm)	26" (660 mm)
CWB-6	82.125" (2086 mm)	83" (2108 mm)	25.19" (640 mm)	26" (660 mm)

SPECIFICATIONS Refrigerated Drop-In Wells

The shaded areas contain electrical information for International models

Model†	Dimensions Δ (Width x Depth x Height)	Voltage	HP Compressor Size	Watts	Amps	Phase	Plug	Ship Weight
CWB-1	19" x 27" x 25.5" (483 x 686 x 648 mm)	120	1/4	804	6.7	Single	5-15P	133 lbs. (60 kg)
		220/230/240	1/3	616-744	2.8/2.9/3.1		BS, CEE, AS	
CWB-2	32" x 27" x 25.5" (813 x 686 x 648 mm)	120	1/4	804	6.7		5-15P	175 lbs. (79 kg)
		220/230/240	1/3	616-744	2.8/2.9/3.1		BS, CEE, AS	
CWB-3	45" x 27" x 25.5" (1143 x 686 x 648 mm)	120	1/4	804	6.7		5-15P	213 lbs. (97 kg)
		220/230/240	1/3	616-744	2.8/2.9/3.1		BS, CEE, AS	
CWB-4	58" x 27" x 25.5" (1473 x 686 x 648 mm)	120	1/3	1044	8.7		5-15P	235 lbs. (107 kg)
CWB-5	71" x 27" x 25.5" (1803 x 686 x 648 mm)	120	1/2	1380	11.5		5-15P	270 lbs. (123 kg)
CWB-6	84" x 27" x 25.5" (2134 x 686 x 648 mm)	120	1/2	1380	11.5		5-15P	313 lbs. (142 kg)

† Models shipped with electronic temperature control, pan support bars for full-size pans, condensing unit (can be rotated), auto-defrost, sight glass, service valves and dryer.
 Δ For CWB-X models only, add 5.05" (128 mm) to the height for the attached solenoid valve.

PLUG CONFIGURATIONS

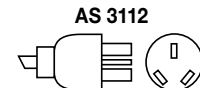
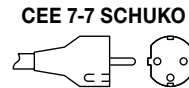
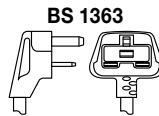
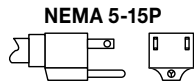

PRODUCT SPECS Refrigerated Drop-In Wells

The NSF 7 approved Refrigerated Drop-in Well shall be a Model ... as manufactured by the Hatco Corporation, Milwaukee, WI 53234 U.S.A.

With 24/7 parts and service assistance (U.S. and Canada only), the Refrigerated Drop-in Well shall be rated at ... watts, ... volts, ... hp, and be ... inches (millimeters) in overall width and be ... inches (millimeters) in overall depth. It shall utilize R-404A refrigerant and consist of aluminized steel housing with a stainless bezel, an

electronic temperature control, pan support bars for full-size pans, condensing unit (can be rotated), compressor, flexible refrigerant lines, sight glass, service valves, receiver, and dryer/filter.

Accessories may include pan support bars, false bottom, trivets and stainless steel food pans.

Warranty consists of 24/7 parts and service assistance (U.S. and Canada only).

HATCO CORPORATION | P.O. Box 340500 Milwaukee, WI 53234-0500 U.S.A. | (800) 558-0607 | (414) 671-6350

Fax: (800) 543-7521 | Int'l. Fax: (414) 671-3976 | www.hatcocorp.com | equipmentsales@hatcocorp.com | intl@hatcocorp.com